

SU150-FP - SINGLE UNION POLY-BALL VALVE

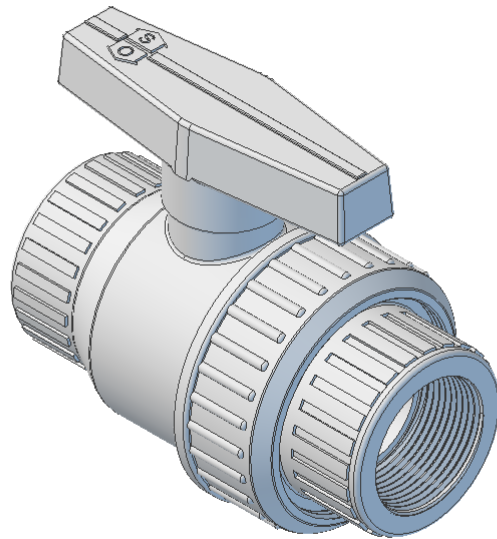

MATERIAL - POLYPROPYLENE WITH TEFLON SEATS
EPDM O-RINGS