

125C-(*) FEMALE COUPLER/ HOSE SHANK

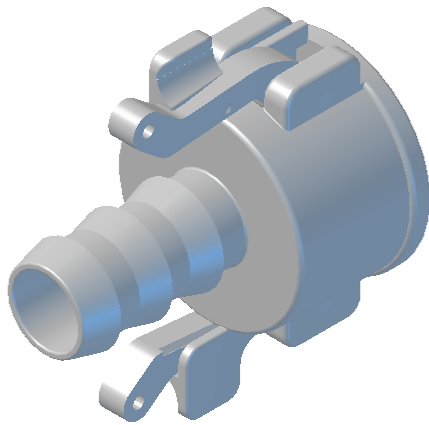

MATERIAL (*) DESIGNATION
(M) = POLYGLASS
(N) = NYGLASS
(F) = FOODFLO
(V) = PVDF