

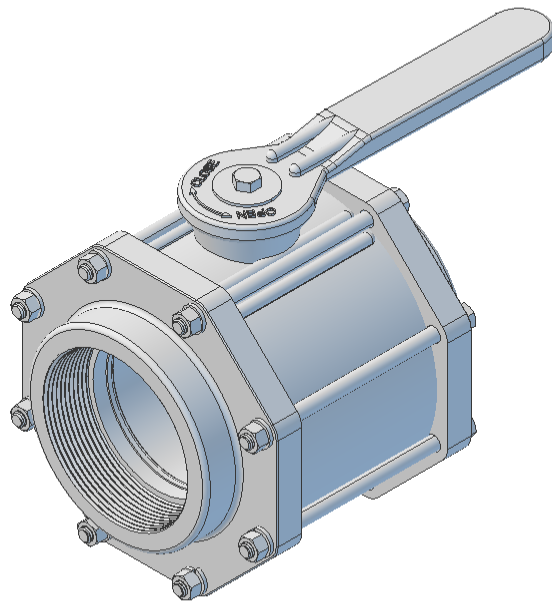

7012A-20 - 4" FULL PORT - BOLTED BALL VALVE



MATERIAL - POLYPRO  
POLYTEF  
VITON  
SS HARDWARE