

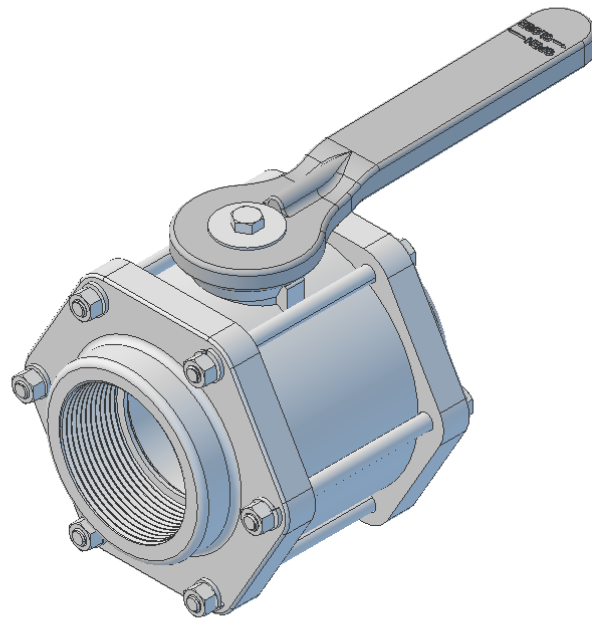

4012Z-00 - 3" FULL PORT - BOLTED BALL VALVE



MATERIAL - POLYPRO
POLYTEF
VITON
SS HARDWARE