

100-C FEMALE COUPLER / HOSE SHANK

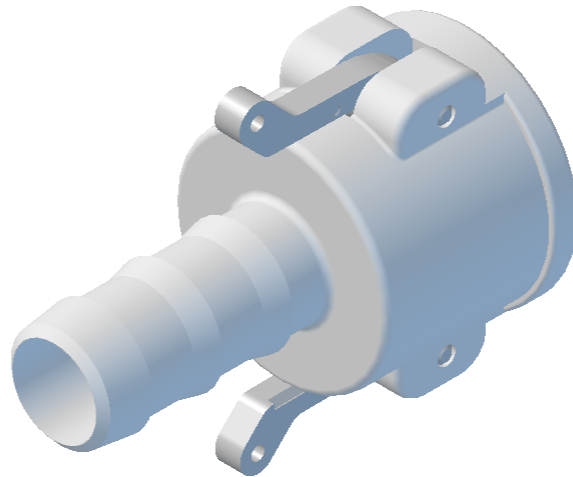

MATERIAL - POLYGLASS